

MAIN SAIL - M

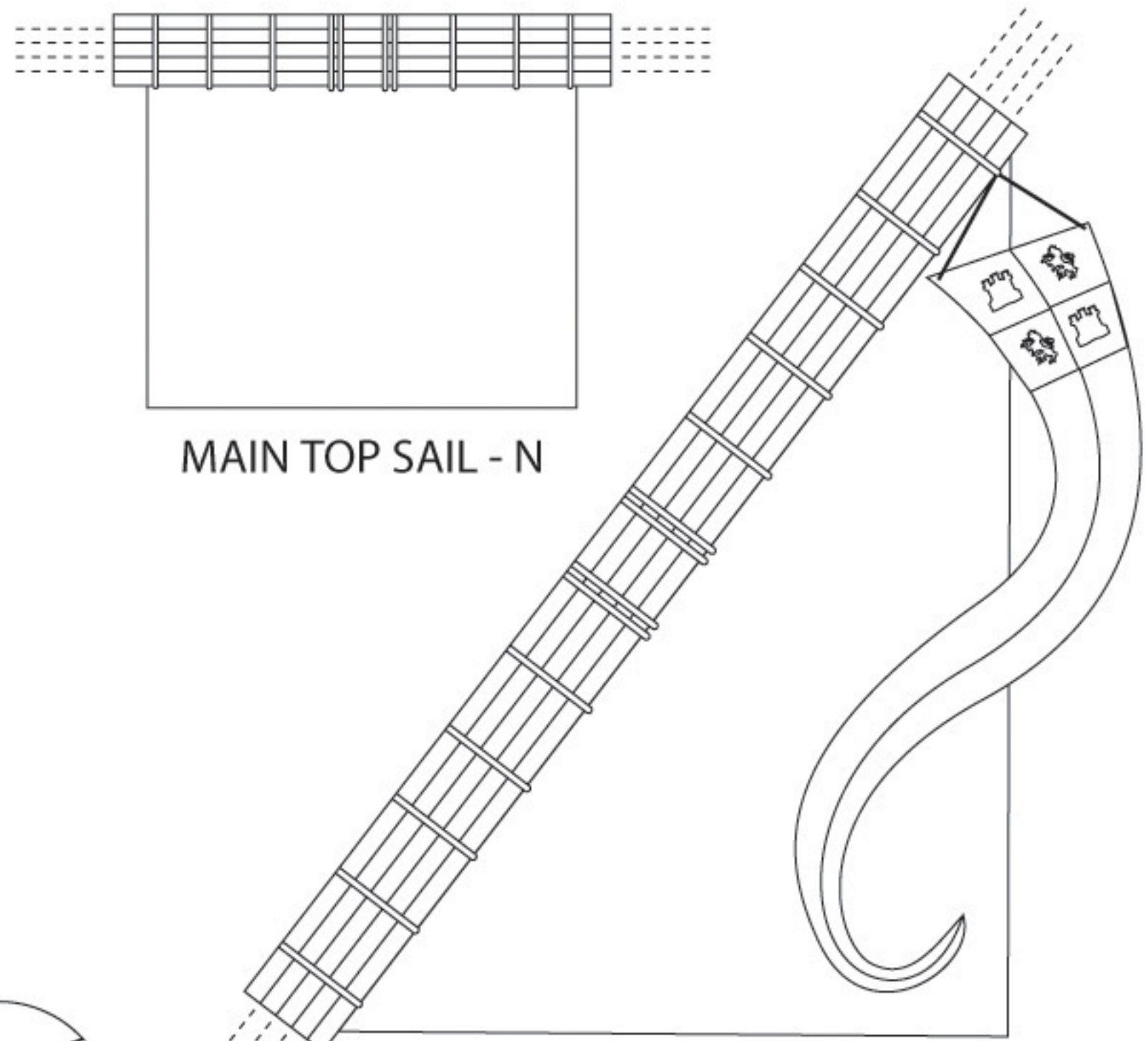

MAIN TOP SAIL - N

MIZZEN (AFT) SAIL - O

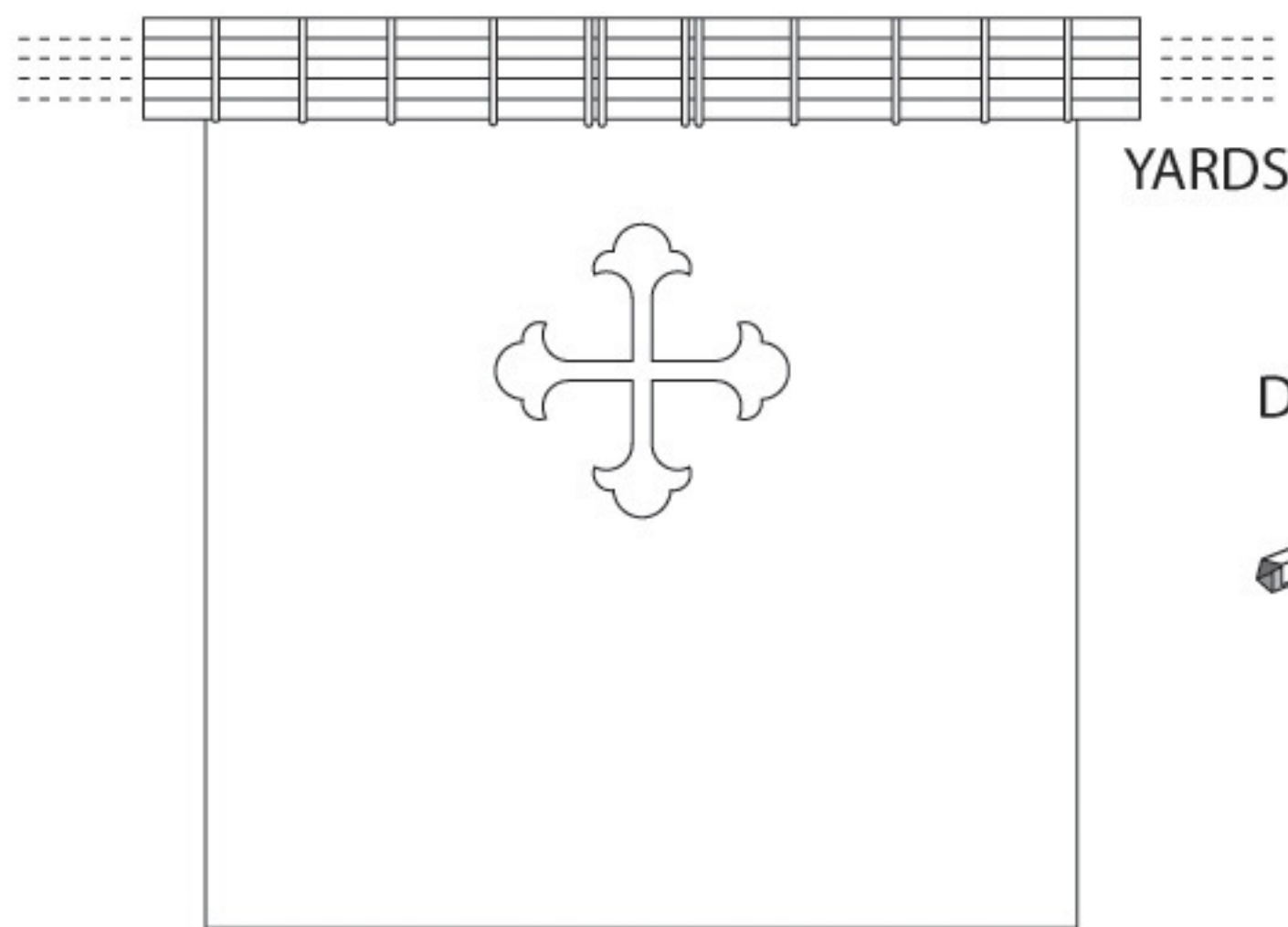

FORE SAIL - L

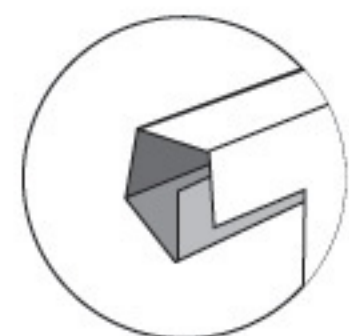

DETAIL 2



SPRIT (BOW) SAIL - K

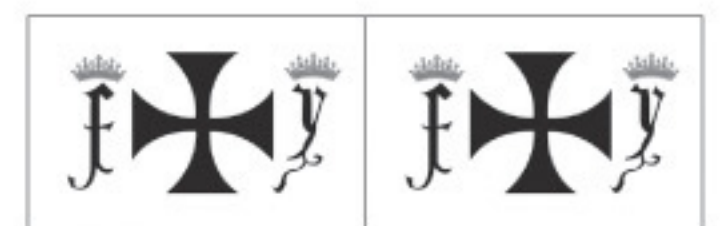
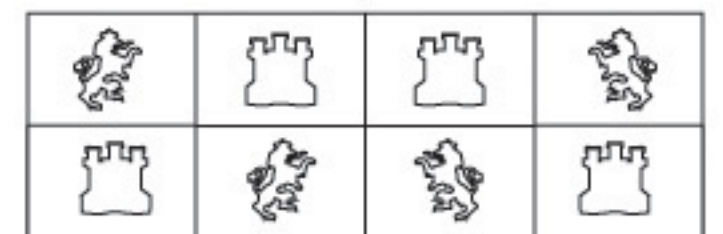
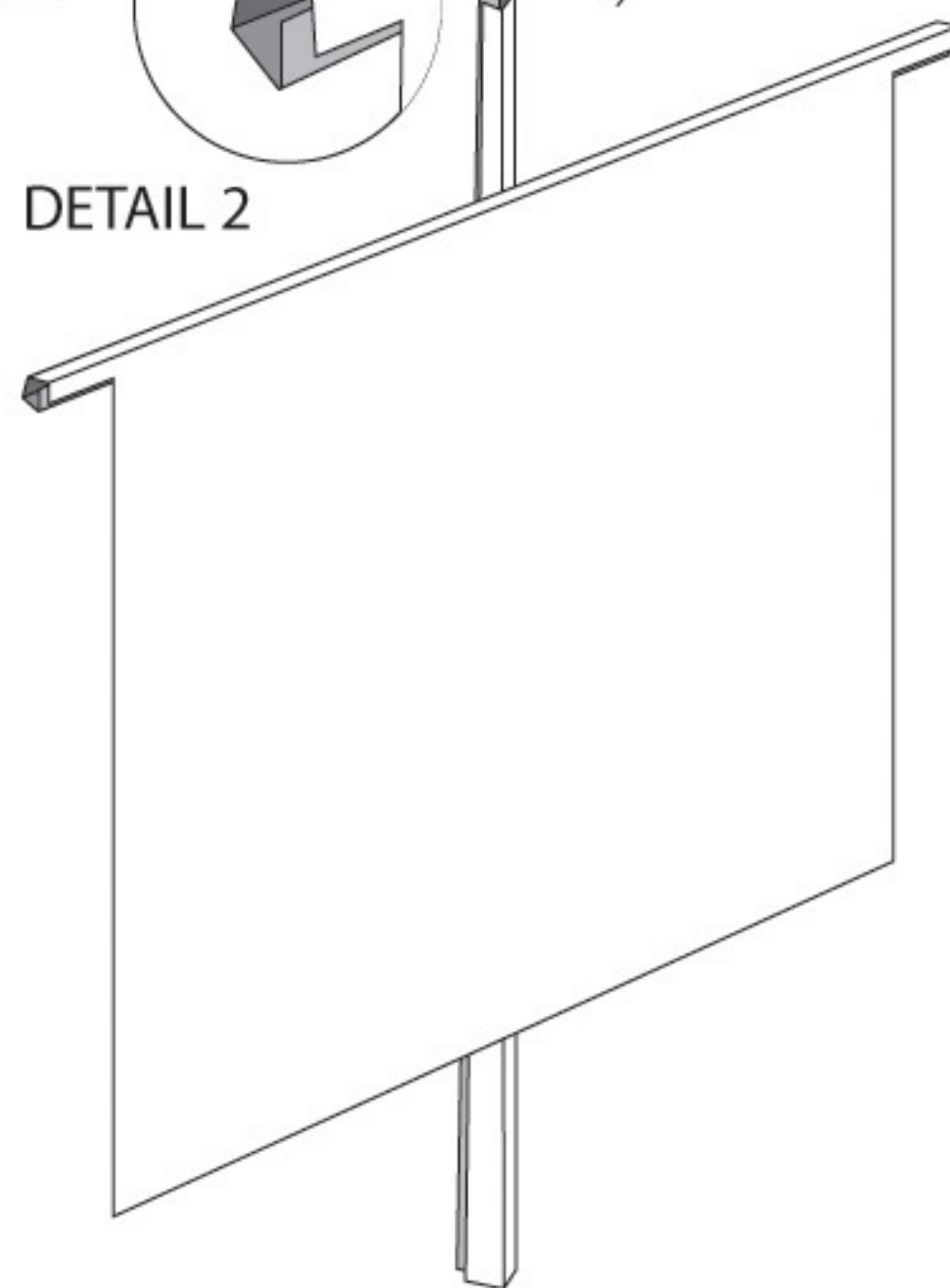

FLAGS R

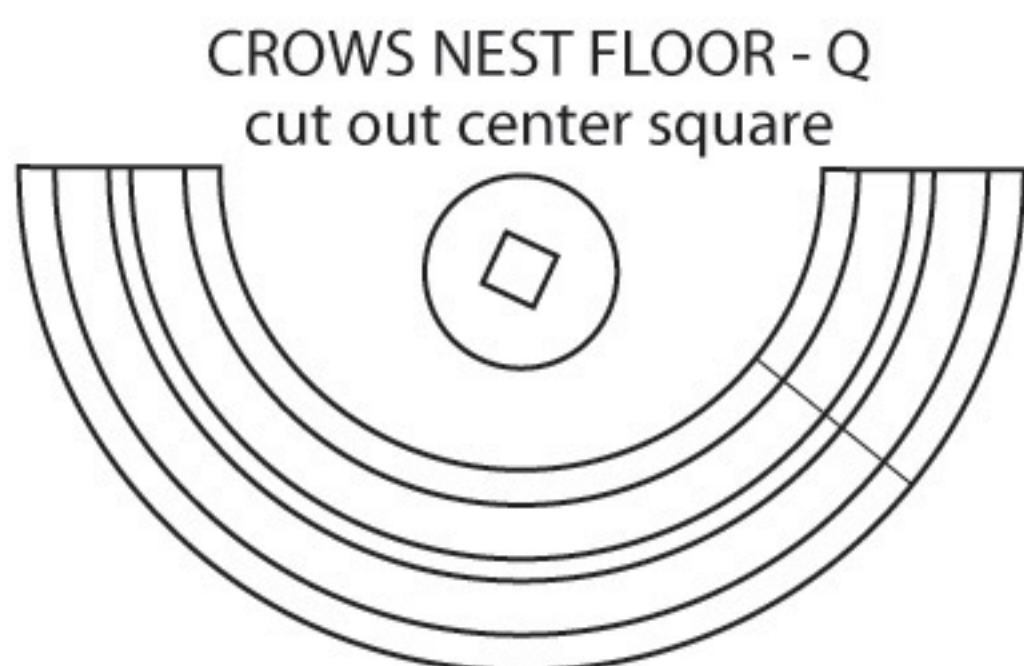

CROWS NEST FLOOR - Q
cut out center square

CROWS NEST - P

INSTRUCTIONS - B

1. Fold all 4 MASTS G H I J, and glue the fifth side inside of each, to create a square tube. (detail 1)
2. Fold the YARDS at the top of the SAILS K L M N O, and glue the fifth side inside. (detail 2)
3. Glue the CROWS NEST P to the CROWS NEST FLOOR Q, and slip down the MAIN MAST I
4. Glue the SAILS to the MASTS, and the MASTS to the DECKS
5. Glue the SHROUDS to the SIDES and MASTS
6. Glue the FLAGS R to toothpicks and insert in the tops of the masts